

N.E.W.S. LETTER

The Official Publication of the North East Weak Signal Group – [N.E.W.S. - Home \(newsvhf.com\)](http://newsvhf.com)

March 2024

Volume 32

Issue 2

Next Meeting: March 23, 2024.

In This Issue

Treasurer's Report and Minutes from the last NEWS meeting , Weekly calendar	page 2
Officers., Polo Shirts and Hats	page 3
47 th Eastern VHF/UHF Microwave Conference	page 4 - 6
For Sale	page 7
K1MAP/B Club Trustee , QST Magazine ,10.368.400 Beacon	page 8
Club Commission Program, EME Conference, Calendar 2024	page 9
Unconditionally Stable Low-Noise MMIC Amplifiers W1GHZ	page 10-14
Supporters	page 15
Membership application	page 16

GENERAL MEETING - STORRS LIBRARY -

1 PM to approximately 3:45 PM.

693 Longmeadow St, Longmeadow, MA 01106

<https://www.longmeadowlibrary.org/>

BOARD MEETING - 11:00 AM at Lulu's, 151 Hazard Ave. Enfield, CT
Phone: (860) 763-2377 I-91 Exit 47 Rt. 190E 1 Mile on Left <http://luluspizzeria.com>

DON'T FORGET

**The North East Weak Signal Group 2 Meter Net
Every Thursday at 8:30 PM local 144.250 MHz
K1BXC Net Control**

MEMBERSHIP in the N.E.W.S Group is \$10 per 2 years.

Apply to George Collins, KC1V. E-mail: news.kc1v@gmail.com.

You may download an application from our web page: <http://www.newsvhf.com>

The N.E.W.S. LETTER is the publication of the North East Weak Signal Group.
Articles may be reprinted with proper credit given to the author and the N.E.W.S. LETTER.

Send articles by e-mail to Don Twombly at donw1fkf-news@yahoo.com.

REMINDER: 222 MHz Activity Night Tuesdays 7 to 11 PM

NEWS Meeting 6 January 2024

at Storrs Library, Longmeadow, MA

and by ZOOM

Called to Order by Vice-President, KA1SUN, at 1314

TREASURERS REPORT

Balance \$2668

5 renewals

43 Members

3 Life

13 Permanent

48 members not renewed yet

ELECTION OF OFFICERS

President W2AAU

Vice President KA1SUN

Treasurer KC1V

Secretary W1GHZ

Directors - All current directors relected

UNANIMOUS

New member WA1NLG. Made his 1st 6 meter EME contact recently

OLD BUSINESS

KC1V - Club hats \$20 shirts & 35-40 add call \$14

K1MAP - Conference waiting to sign contract

2024 meeting schedule

23 March

13 July

28 Sept

23 Nov

4 Jan 2025

SUGGESTION:

Membership list - add expiration date, Town, State, and Grid. Include in PDF on website. Approved by consensus

ANNOUNCEMENTS

Berkshire repeater now has TAC316 fulltime/

KV1J/B 10 Ghz beacon in FN44 is on the air.

10368.400 FN44rc05gn Otisfield, Maine, 890 ft ASL

ADJOURN 1334

Followed by test session - test equipment by W2AAU & friends



Weekly Calendar

Mon. Packrats Nets start at 7:30pm on 6 meters, 8 pm on 144.150, etc. Philadelphia area.

Tues. Mud Toads Net FM 17, Virginia 8 pm 144.250

Tues. Activity Night 7:30pm 222.100 K1WHS +

Weds Activity Night 432 K1FMS (N1DPM) +

Thurs. NEWS net, 8:30pm 144.250

Sat. Chesapeake Net 144.205 W3BFC FM28 9 pm

144.205 Mornings 8:30-9:30 AM -- 144.205 , 144.190, ME, Canada to NC and out to OH, WV

Officers:

President Dick Frey, WA2AAU, Delanson, NY
Vice Pres. Eric Mazur, KA1SUN, Savoy, MA

Treasurer George Collins, KC1V, Somers, CT
Secretary Paul Wade, W1GHZ, Cabot, VT

Board Of Directors:

Tom Cefalo W1EX N Reading MA
Tom Williams WA1MBA Orleans, MA
Bob Bownes KI2L, Troy, NY
Mark Casey K1MAP, Hampden, MA



Order List
WHO is interested In
Polo shirts and Hats embroidered with Club Logo
Polo Shirts \$28 Hats \$19
Please contact Don W1FKF donw1fkf-news@yahoo.com

<https://www.sanmar.com/>
C813 Cap
K500P Polo Shirt
Embroidered by:
<https://stitchesnh.com/>

We need a minimum order



K500P SALE PORT AUTHORITY
Port Authority® Silk Touch™
Polo with Pocket



Starting at: \$20.98 [Check Inventory and Pricing](#)

Adult Sizes: XS-6XL

Color selected: Stone

<input type="checkbox"/> Black	<input type="checkbox"/> Burgandy	<input type="checkbox"/> Cool Grey	<input type="checkbox"/> Dark Green
<input type="checkbox"/> Navy	<input type="checkbox"/> Red	<input type="checkbox"/> Royal	<input checked="" type="checkbox"/> Stone
<input type="checkbox"/> Ultramarine Blue	<input type="checkbox"/> White		

C813 PORT AUTHORITY
Port Authority® Flexfit®
Cotton Twill Cap



Starting at: \$11.98 [Check Inventory and Pricing](#)

Adult Sizes: S/M, L/XL

Color selected: Stone

<input type="checkbox"/> Black	<input type="checkbox"/> Forest Green	<input type="checkbox"/> Graphite	<input type="checkbox"/> Gusty Grey
<input type="checkbox"/> Kelly Green	<input type="checkbox"/> Maroon	<input type="checkbox"/> Orange	<input checked="" type="checkbox"/> Stone
<input type="checkbox"/> True Navy	<input type="checkbox"/> True Red	<input type="checkbox"/> True Royal	<input type="checkbox"/> White

Sample Polo Shirt and Hat at March Meeting

**47th EASTERN VHF/UHF/MICROWAVE CONFERENCE:
APRIL 19-21, 2024
Hilton Garden Inn (860)-688-6400
555 Corporate Drive, Windsor, CT 06095
(I91 exit 38 to Day Hill Rd**

4/18/24 THURSDAY Early Arrivers
6-9pm Meet in bar

4/19/24 FRIDAY LODGING
12:30PM Early Arrivers Lunch - meet K1MAP (413-222-9292) in Lobby
2:00-5PM Afternoon Workshop TBD
6:00pm HOSPITALITY ROOM (BYOB due to Hotel rules)
7:30pm Indoor SWAP/SELL & VENDORS.

**4/20/24 SATURDAY REGISTRATION, TALKS, AUCTIONS, TEST LAB , VEN-
DORS & MORE.**

Schedule Details Coming SOON

7:30am REGISTRATION BEGINS
8:15 am OPENING ANNOUNCEMENTS
8:30am TALKS BEGIN (see SCHEDULE):
11:30pm LUNCH (Grinders at Jim's Restaurant)
1:15pm TALKS RESUME
4:15pm TALKS CONCLUDE
5:00pm NEWS MEETING - W2AAU
5:30pm Pre-Banquet Hospitality Room
7:00pm BANQUET BUFFET (7 PM - 8:30 PM)
8:20pm Tom Kirby Award Presentation
9:00pm DOOR PRIZE EXTRAVAGANZA, Michele Clement W1MKY
and Don Twombly W1FKF

Schedule Details Coming SOON

Super Test Lab up to 122 GHz

4/21/23 SUNDAY
9:00am-11am VHF+MW SWAP/SELL at Vintage Radio & Communications Museum

****NO EARLYBIRDS** & VENDORS (8AM setup),
(included with Registration- Please contact Mark Casey K1MAP
for details)
EVERY REGISTRANT IS ELIGIBLE FOR PRIZE DRAWINGS.**

**47th EASTERN VHF/UHF/MICROWAVE CONFERENCE:
APRIL 19-21, 2024
Hilton Garden Inn (860)-688-6400
555 Corporate Drive, Windsor, CT 06095
(I91 exit 38 to Day Hill Rd)**

Presentations (preliminary 3-1-24)

FRIDAY Afternoon 2 to 5 pm

Workshops – *Learn by doing!*

nanoVNA – Hands on workshop on using this inexpensive but powerful pocket-sized instrument, from basics to advanced measurements. If you have one (any version), bring it along so you can follow and participate in the demonstrations. *~2 hours*

TinySA - Hands on workshop on using this inexpensive but powerful pocket-sized spectrum analyzer, from basics to advanced measurements. If you have one (any version), bring it along so you can follow and participate in the demonstrations. *~1hour*

SATURDAY

WA1MBA	LDMOS IMD
KI2L	6-band Rover Controller
K6JEY	Comparison of Wattmeter Accuracy at 1296 MHz
KI2L	Audio Switching for SO5R
W1GHZ	Unconditionally Stable MMIC LNA
N6IZW	Arduino-based remote for Spectrum Analyzers and Power meters
K6JEY	Modern Multimeters with Bluetooth
KI2L	GPSDO PLL+
W9JJ & N1SFE	Contest Update Forum

More Presentations Needed!

DIRECTIONS & RESERVATIONS

Hilton Garden Inn at Bradley Airport, Windsor, CT
+1 860-688-6400

The conference rate for Thursday, Friday, Saturday and Sunday night is \$149 per night which includes breakfast for two.

Available rooms are King or two doubles.

We encourage everyone to register for the hotel as early as possible.

The hotel direct link is:

[Hilton Garden Inn at Bradley Airport, Windsor, CT](#)

The hotel address is 555 Corporate Drive, Windsor, CT 06095

A complimentary shuttle is available from Bradley Airport +1 860-688-6400

MORE DETAILS WILL BE ADDED SOON - check back often.

**If you are interested in presenting a paper at the conference
or submitting one for the Proceedings please contact: Paul Wade, W1GHZ**

Questions? Contact one of the 2 Conference Co-Chairmen:

Paul Wade, W1GHZ, (presentations, proceedings)

Mark Casey, K1MAP, (hospitality, hotel, swaps/vendors)

cell 413-777-9828, home 413-566-2445.

[Email W1GHZ](#) [Email K1MAP](#)

Door Prize Coordinators:

Michele Clement W1MKY, Don Twombly W1FKF and Lanette Twombly KA1NKD

SHIP DOOR PRIZES TO:

Don Twombly, W1FKF

32 Bumfagon Rd.

Loudon, NH 03307

If you would like to donate a Door Prize please contact

[Email W1FKF](#) [Email W1MKY](#)

_SWAP n SELL INFO:

MARK CASEY, K1MAP

303 Main Street

Hampden, Mass 01036

(413) 566-2445 (home) or 413-222-9292 (cell)

[Email K1MAP](#)

* Sponsored by the North East Weak Signal Group

* ARRL-Affiliated Official Webpage: <http://www.newsvhf.com>

For Sale - Henry, KT1J 03/01/2024

All items plus shipping. Reasonable Offers Considered

Please reply to Henry or me via QRZ address.

(N1JEZ)

2 kW 6M Linear (2 x Harris 1kW amps, 2 x HP PSU's, tested 1800W) with spare module \$1900

300W 2M amp complete in case. 15W in for 300+ out. 48v \$350

25 watt 2M Semcoset amp. 3 in 25 out with relays in box. 12v. \$75

Minikits 1296 amplifier. 15 watt. Uses Mitsubishi RA18H1213G Module 12v \$75

UT5JCW "Ukranian" 6M Transverter Tested. In case. Includes input attenuator \$95

UT5JCW "Ukranian" 70cm Transverter Tested. In case. Includes input attenuator \$95

PA3BIY 2M preamp 0.26NF 22 dB gain \$200

PA3BIY 2M preamp similar to above with adjustable filter (commercial 2-way rejection) \$250

Piezo ovenized 10 MHz OCXO #2920136 +24v \$20

1 x 5 filtered 10 MHz Distribution Amp board. BNC output connectors. 12v \$5

DEMI 10-4 built in metal enclosure \$75

GPS Timing antenna with pole mount \$25

Analog Devices ADALM Pluto Rev B SDR \$125

ADF4351 PLL - programmable (via switches on board) signal generator board with display 137 MHz - 4.4 GHz \$25

TME URA-110MD attenuator. 0-10 dB in 1 dB steps. 1 watt to 3 GHz \$40

RCA small antenna rotor & controller \$125

Thrust bearing (max 2 3/4 inch mast) \$50

TGE Booster – regulator. 9-14V in, 12V out \$75

Short yagi 222 MHz 5 el, 47 inch, square boom \$60

Short yagi 432 MHz 5 el, 30 inch, square boom \$60

Short yagi 903 MHz 9 el, 30 inch square boom \$60

Short yagi 2.4 GHz 22 el., 65 inch round boom \$60

2M Loop Antenna, PAR Electronics 0A-144 \$40

DXEng - Core Feedline Current Choke 1-60 MHz \$75

Quick Connect aluminum tripod base \$25

TH-F6A 144/220/440 MHz FM portable \$100

Tripod. with 8 inch compass rose \$100

30 inch aluminum dish w shroud - make offer

24 GHz filters and couplers LOT - make offer

Bird 4304 mod., new meter element \$50

Tripod Samson Model 730, modified \$50

N8XJK Booster Regulator 9-14V, 12v out at 30A \$155

DEMI LTRSB Sequencer Kit \$25

IC706MKIIG compact transceiver, 10-160M : 100W, 2-6-432: 50W. \$475

IC AH-4 mobile tuner for above. \$100

10' remote cable for use between IC706 transceiver & front panel \$75

Signalink USB \$100

SMA relays list:

https://drive.google.com/file/d/155iAtCVFSQ_5-W5sStl4NfC9AH5SPuch/view?usp=sharing

(N1JEZ)

K1MAP/ Beacons

map92map@gmail.com

Starting about April 5, there will be 2 Beacons, both using short yagis pointed up the coast towards New England, NY, NJ, PA from Cedar Island, NC FM14ux, which is near Cape Hatteras.

W4FWS/b 144.282 30 watts

K1MAP/b 222.054 10 watts

And, after April 10, this beacon, using an omni antenna will be on from Hampden, MA, FN32sb, which is a few miles east of the NEWS Meeting location in Longmeadow, MA, near Springfield, MA and Hartford, CT.

K1MAP/b 432.315 10 watts

Looking for new Club Trustee

Must be control op for beacons (now on RR property). Is a younger person willing?

Renewal is next year.

[for more info](#)

Contact Ron WZ1V wz1v@arrl.net

QST Magazine

After September 1st 2023 and before July 1st 2024 existing ARRL Life Members need to let the ARRL know they wish to continue to get their mailed magazine, or the implied default action is that they will be converted to a "Life Digital Member" to save the ARRL printing and postage

New location of 10368.400 Beacon: FN44RC05gn

KV1J Otisfield Maine
Ground elevation 838 ft
antenna 50 ft above ground

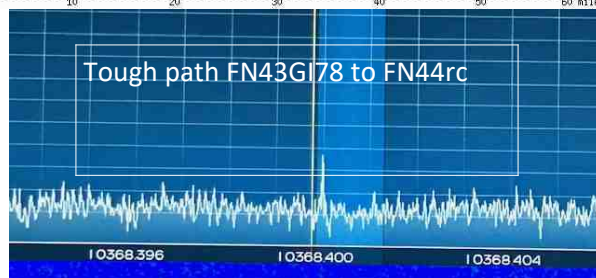
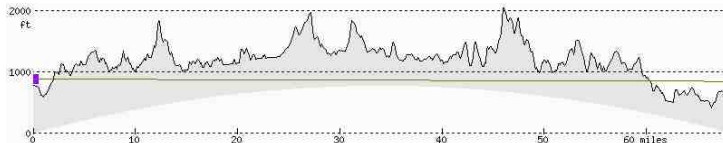
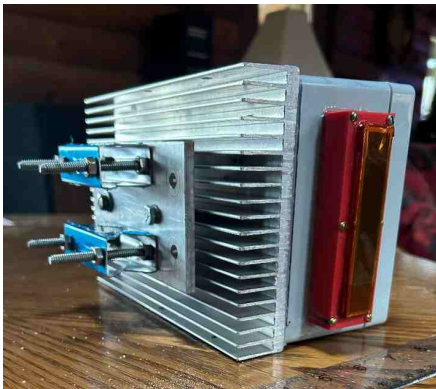

Club Commission Program

Each new ARRL STANDARD membership earns the club a \$20 commission (family, student/youth, and blind memberships are not eligible). New members are defined as never having been a member or a returning member that has not been a member for two years. Each renewal now earns the club a \$5 commission. There is no limit to the amount a club can earn in this program.

Members can renew anytime without losing any of their membership time. Details and forms are available on the ARRL web site, at www.arrl.org/affiliated-club-benefits. FAQs are also available to help explain the program. It does take some effort and a bit of paperwork, but the club reaps the reward in cash. If your affiliated club is not participating in this program, ask them to investigate it.

<https://eme2024trenton.org/>

International EME 2024 Conference

August 9th to 11th, 2024



2024 EME Conference

August 9th to 11th, 2024

Don't miss the EME 2024 Conference, happening near Trenton, NJ (in Ewing). Hosted at The College of New Jersey campus, centrally located near Washington DC, Philadelphia and New York City, this conference is dedicated to exploring the fascinating world of Earth-Moon-Earth Communications (EME). Join us at the 20th EME Conference to learn from expert speakers in the field and discover the latest advancements in Moon-bounce.

Calender 2024

March 23, 1PM - 4PM - [N.E.W.S. Group Meeting](#)

April 1, 1900-2300 Local - [144 MHz Spring Sprint](#)

April 16, 1900-2300 Local - [222 MHz Spring Sprint](#)

April 18-21 - [Eastern VHF-UHF Conference](#)

April 22 - Lyrids meteor shower

April 24, 1900-2300 Local - [432 MHz Spring Sprint](#)

April 25-26 - [New England Amateur Radio Festival - Deerfield, NH](#)

May 4, 0800-1300 Local - [Microwave Spring Sprint](#)

May 11-12, 2300-0300Z - [50 MHz Spring Sprint](#)

May 17-19 - [Dayton Hamfest](#)

June 8-10, 1800Z-0300Z - [ARRL June VHF OSO Party](#)

July 13, 11AM - 4PM - [N.E.W.S. Group Picnic](#)

July 20-21, 1800Z - 2100Z - [CO Worldwide VHF Contest](#)

August 3-4, 1800Z - 1800Z - [ARRL UHF Contest](#)

August 9-11 - [EME2024 Conference - Trenton, NJ](#)

August 10-11, 2300-0300Z - [50 MHz Fall Sprint](#)

August 11-12 - Perseids meteor shower

August 17-18, 6AM - 11:59:59PM - [ARRL 10-GHz & up Cumulative Contest](#)

September 9, 1900-2300 Local - [144 MHz Fall Sprint](#)

September 14-16, 1800Z-0300Z - [ARRL September VHF OSO Party](#)

September 17, 1900-2300 Local - [222 MHz Fall Sprint](#)

September 25, 1900-2300 Local - [432 MHz Fall Sprint](#)

September 28, 1PM - 4PM - [N.E.W.S. Group Meeting](#)

October 3-5 - [Microwave Update 2024 - Vancouver, BC](#)

October 5, 0600-1300 Local - [Microwave Fall Sprint](#)

October 11-12 - [New England Amateur Radio Festival - Deerfield, NH](#)

November 18 - Leonids meteor shower

November 23, 1PM - 4PM - [N.E.W.S. Group Meeting](#)

December 13 - Geminids meteor shower

Unconditionally Stable Low-Noise MMIC Amplifiers for VHF & Up

Paul Wade W1GHZ ©2024

w1ghz@arrl.net

There are several MMICs available that provide very low noise figures for VHF to low microwave frequencies, with no tuning needed. One problem with these broadband amplifiers is that they also amplify out-of-band signals, which can create IMD which may make the signal-to-noise ratio worse rather than better.

For instance, on 222 MHz at my QTH, the apparent noise floor rises more than 10 dB in certain directions. A PGA-103 MMIC preamp improves the signal-to-noise ratio (SNR) in quiet directions, but does not help in the noisy directions. I use an SDR panoramic display to judge the SNR on a weak beacon signal – the noise floor is the baseline level. Adding a good bandpass filter before the preamp improved things in all directions, even though it has about 1 dB loss; the noise floor now only rises about 3 dB in the worst direction, a tolerable situation. However, when I tried a sharper bandpass filter, the preamp seemed to oscillate, with no weak signals getting through.

The PGA-103 MMIC preamps measured very good noise figure from 2 meters up to 1296 MHz at conference measurements, but occasionally acted strangely in various setups, suggesting possible stability problems.

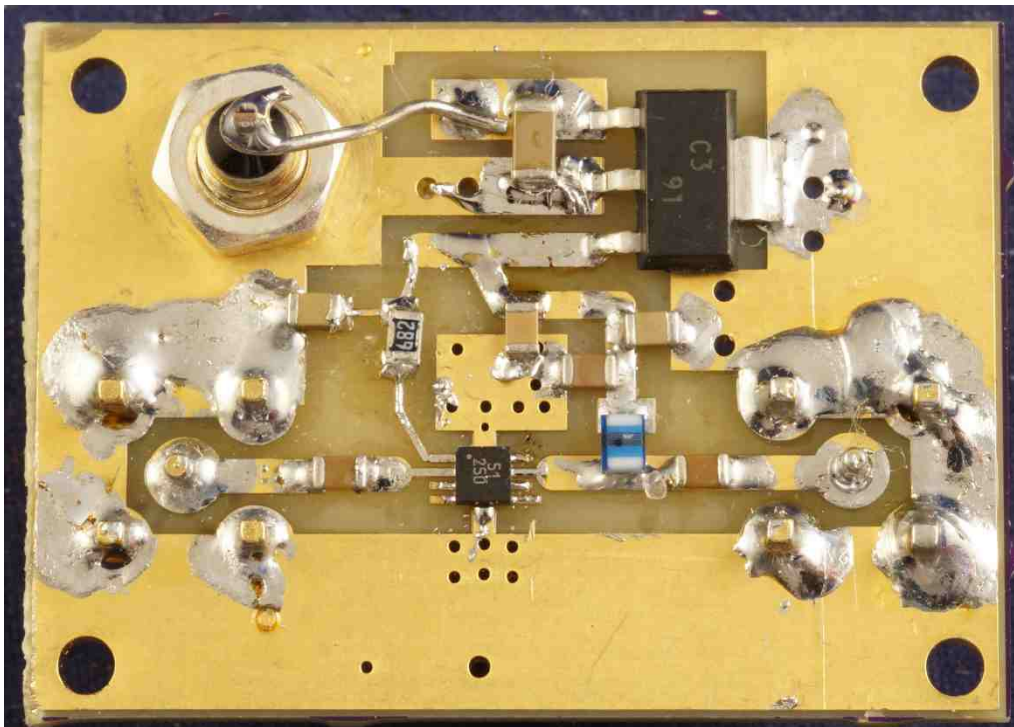

Figure 1 – Unconditionally stable MMIC LNA

Unconditionally Stable MMIC

I am always on the lookout for useful new MMICs and equipment. Don, W1FKF, frequently finds some interesting stuff that I can't resist! Recently, while preparing a Mouser parts order, I came across a new MMIC from NXP, the BGU8051, described as a low noise high linearity amplifier from 0.3 to 1.5 GHz. Specs state unconditionally stable, $K > 1$ up to 20 GHz and NF of 0.43 dB at 900 MHz. The price is about \$3, so I ordered a few to try.

The problem with this MMIC, and many other great-sounding new devices, is the tiny package, a 2mm square SMT package with no leads, only small pads, and a central ground pad underneath. I designed a test PC board and sent it off to OshPark.com – they charge by the square inch, so small PC boards are very economical.

When the board came back, I found that I had gotten the MMIC footprint backwards; the reversed input and output were manageable, but the bias pin was shorted, so it couldn't work. But it was usable to see if I could solder the tiny package. I tried with a hot-air tool but only managed to blow it away. Mike, N1JEZ, came to the rescue – he has calibrated a toaster oven as a soldering oven, for SMT assembly. Mike was able to solder a couple of parts to the PC boards, so I fixed the PC layout and ordered more boards.

Mike soldered parts to the new boards, and they drew current as expected, so I assembled one to test, shown in Figure 1. You can see that the MMIC is about the same size as the chip capacitors.

The schematic diagram in Figure 2 is very simple. The bias resistor, R1, sets the device current. L1 is 47 nH, and C1,2,&3 are 100 pf. Larger values might be better for VHF frequencies.

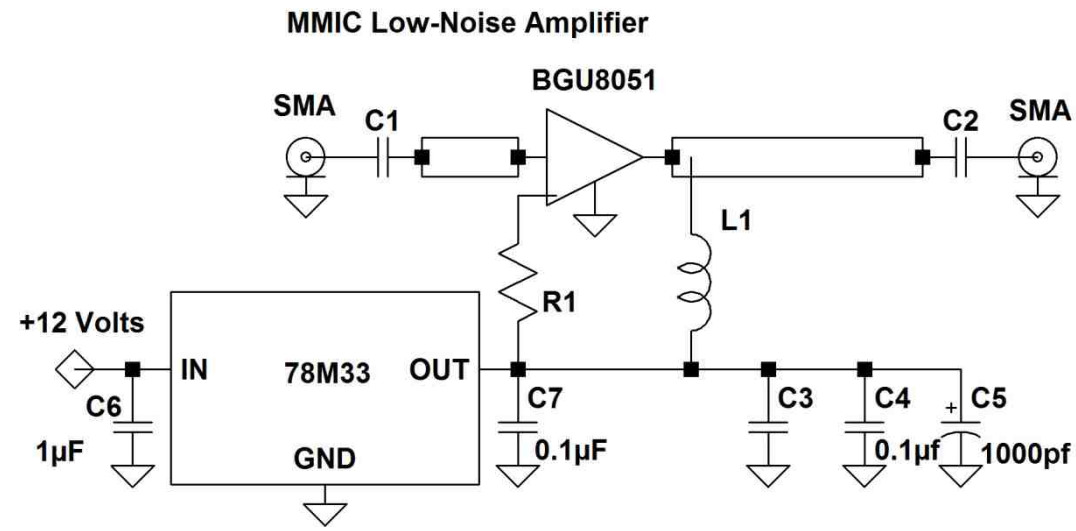

Figure 2 – Schematic diagram of BGU8051 LNA

A quick test with recommended $R1 = 5.1K$ showed good gain and a noise figure of 1 dB or lower at both 144 and 1296 MHz (I don't trust my NF numbers below 1 dB). To look for best NF, $R1$ was replaced with a variable resistor and supply voltage varied from 3 to 5 volts. The sweet spot seemed to be at 3.3 volts and current between 16 and 25 ma ($R1$ 6 to 8K), improving the NF by about 0.2 dB. The final assembly added the 3.3 volt regulator and a 6.8K resistor.

The amplifier gain, measured with a NanoVNA and a 30 dB attenuator to avoid overload, is shown in Figure 3. Gain is more than 20 dB at 144 MHz and about 15 dB at 1296 MHz, with some gain up to at least 3 GHz.

The input return loss, the inverse of $S11$ shown in Figure 3, is very poor below 500 MHz, suggesting that VHF noise figure might be improved with some tuning. This will be investigated when more are assembled.

29 Feb 2024

BGU8051 Preamp
3.3 Volts, 6.8K bias
100pf, 47 nh

W1GHZ

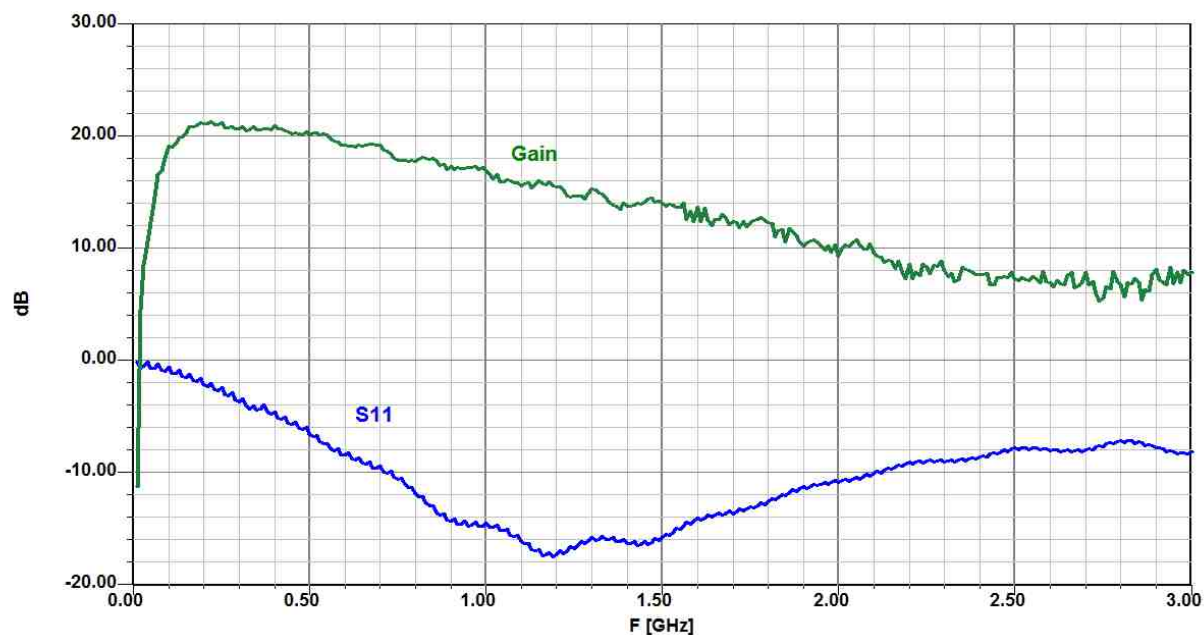

Figure 3 – Performance of BGU8051 Preamp

Other Unconditionally Stable MMICs

Poking around a bit more at Mouser.com found some other promising candidates from Qorvo: the QPL9547, the TQP3M9036, and the TQP3M9037. I then searched on ebay to see if any of these devices were available in assembled PC boards from our friends in the far east, and found the module shown in Figure 4, for about \$25 from a USA shipping vendor.



Figure 4 – TQP3M9037-LNA found on ebay

The module is powered by a USB-C port, making testing easy. A quick check showed noise figure similar to the BGU8051. Putting it on the nanoVNA, Figure 5, showed more gain and better VHF input match. The gain is pretty good to at least 3 GHz – it says 6 GHz on the cover.

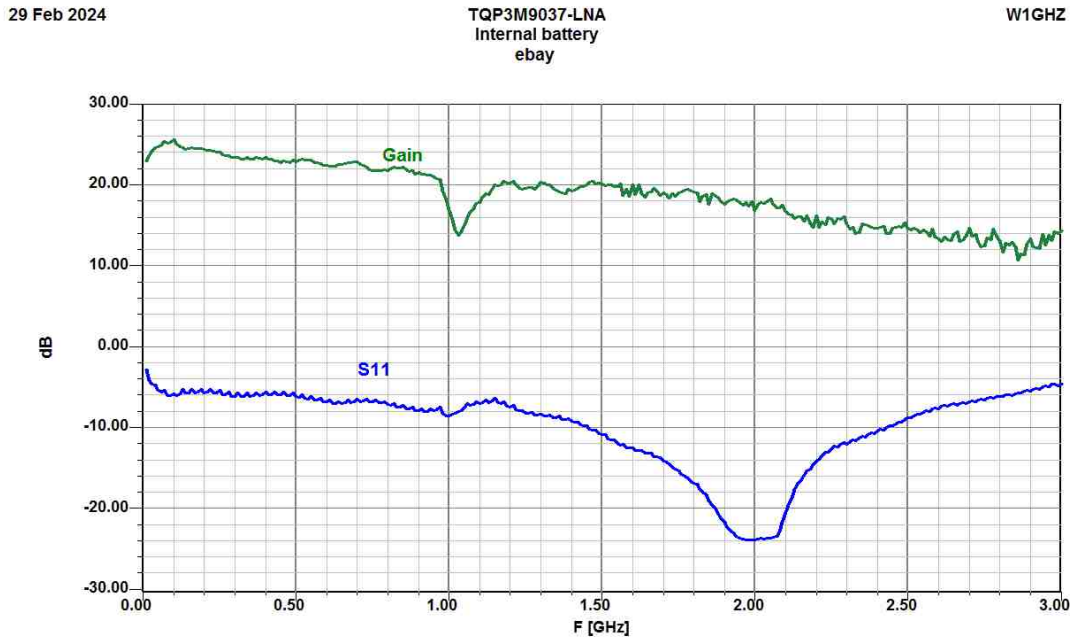

Figure 5 – Performance of TQP3M9037-LNA module

When I opened it up (Figure 6), I found an internal battery and more stuff on the PC board than my simple amplifier. The capacitors and RF choke are much higher value, enhancing VHF performance. There appear to be protective diodes at the input and a provision for powering the amplifier through the output connector.

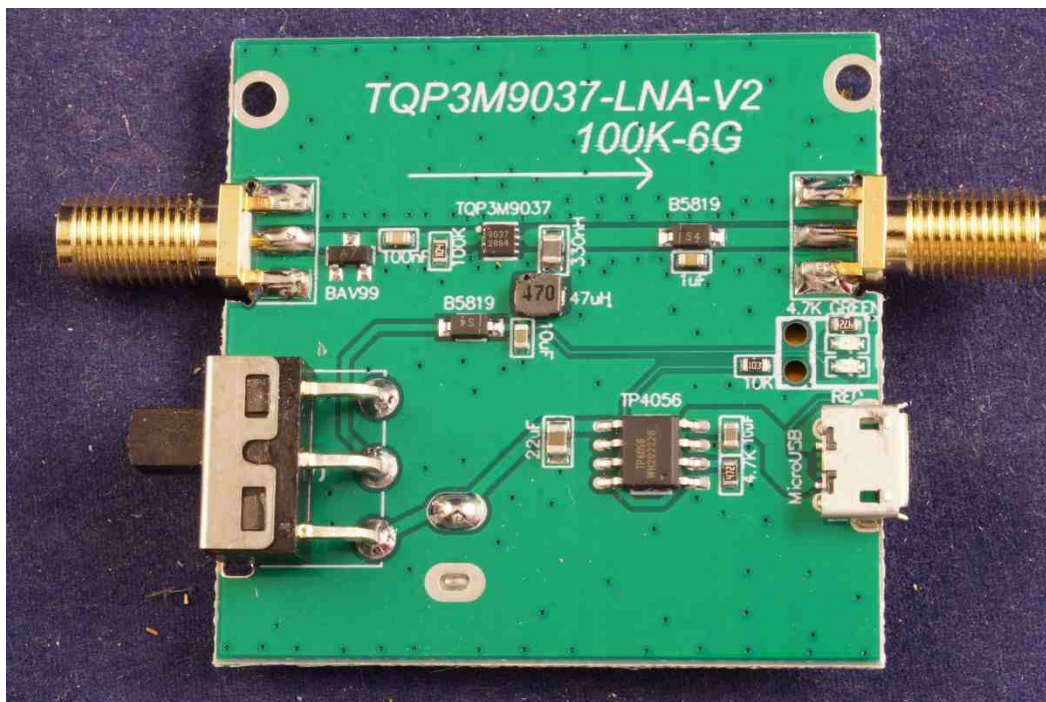

Figure 6 – PC board inside TQP3M9037-LNA module

Summary

While this is still a work in progress, the goal of an unconditionally stable low-noise amplifier may be possible. The noise figure are good enough for anything but EME; actual numbers will be measured at the VHF conference. The remaining problem is soldering these tiny parts.

The ebay module with internal battery looks like a really useful compact LNA, also handy for testing, rover operation, or antenna tests.

More to come...

w1ghz@arrl.net



α ALPHA ANTENNA®



DAIWA



MOUSER ELECTRONICS



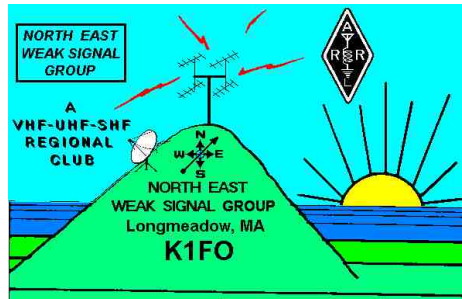

MEMBERSHIP APPLICATION

Date: _____

Name: _____

Call sign: _____ Grid: _____

Street: _____

City: _____ State: _____ Zip: ____ - _____

Phone (home) _____ Optional (work) _____ - _____

Email _____

ARRL member: Y N

Electronic Newsletter Delivery: Y N

Operational Bands (circle)	50 MHz	144 MHz	222 MHz	432 MHz	903 MHz	1.2 GHz	2.3 GHz
	3.4 GHz	5.6 GHz	10 GHz	24 GHz	47 GHz	76 GHz	Light
	Other (list)						

The North East Weak Signal [N.E.W.S.] Group was established in 1993 to form a camaraderie among fellow VHF-UHF-Microwave enthusiasts and support a convenient means to exchange technical information. We currently have six meetings per year, 4 are held on at the Storrs Library on Rt. 5 in Longmeadow, Mass., 1 at our annual Conference in April, and 1 at our Annual Picnic in July. We provide a "NEWSLETTER" that is distributed via email two weeks prior to each meeting. Any contributions to this publication are appreciated and can be sent to: Don Twombly, W1FKF by e-mail to donw1fkf-news@yahoo.com

Dues are \$10 for 2 years. Please contact or mail application to: NEWS Treasurer, George Collins, KC1V, 105 Ninth District Rd., Somers, CT 06071 or E-mail: news.kc1v@gmail.com

Treasurer

North East Weak Signal Group

c/o George Collins KC1V
105 Ninth District Road
Somers, CT 0607
news.kc1v@gmail.com

NEWSLetter

North East Weak Signal Group

c/o Don Twombly, W1FKF
32 Bumfagon Road
Loudon, NH 03307
donw1fkf-news@yahoo.com